

RESIDENTIAL EXTRACT GRILLES

OVERVIEW

UQ SERIES

UQ: Residential extract grilles with square mesh in anodised extruded aluminium.

CHARACTERISTICS:

Frame: made from extruded aluminium, 25 mm wide, with rounded edges, constructed in four parts connected invisibly by mechanical assembly.

Core: consisting of a vertical or 45° inclined square aluminium mesh panel, incorporated into the frame.

Transverse reinforcement: provided on all sizes with base dimension greater than 1000 mm.

Damper, optional: all-steel, with multiple fins with opposing movement.

Mounting frame, optional: sheet steel construction.

Filter holder versions: numerous versions for both washable and rigid filter.

Grille installation: with screwless system with clips;
with traditional screw system directly in the duct or on the wall;
with hidden screw system "U-FIX" and mounting frame.
For ceiling installations, the use of clips is not recommended.

Finish: available in natural anodised aluminium or powder-coated RAL 9010 or RAL 9003.

Other types of painting available on request.

UNSUITABLE ENVIRONMENTS

The aluminum products are not suitable for installation in environments with an atmosphere containing corrosive substances for this material and in particular containing chlorine, such as swimming pools, spas and some types of food industries.

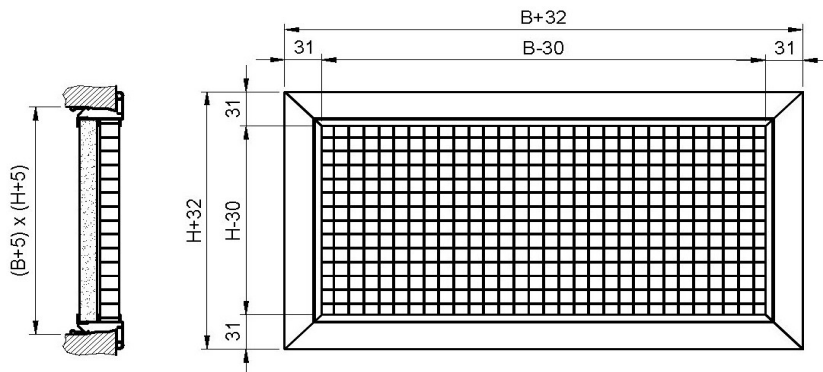
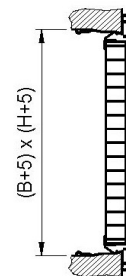
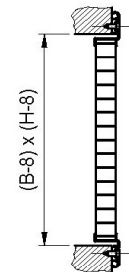
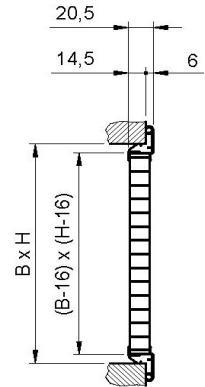

UQCUM

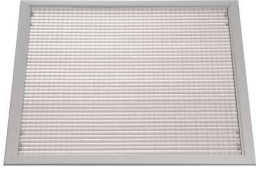

RESIDENTIAL EXTRACT GRILLES

OVERVIEW

UQ SERIES

UQ2: Residential extract grilles with square mesh in anodised extruded aluminium, filterholder frame for washable filter (initial thickness 15 mm), opening system: hinge on upper side (maximum angle 85°) and magnet on lower side.

Installation on wall, not ceiling-mount.

UQ3: Residential extract grilles with square mesh in anodised extruded aluminium, filterholder frame for washable filter (initial thickness 15 mm), opening system: hinge on upper side (maximum angle 85°) and screws on lower side.

Installation on wall or ceiling.

UQ4: Residential extract grilles with square mesh in anodised extruded aluminium, filterholder frame for washable filter (initial thickness 15 mm), opening system: hinge on upper side (maximum angle 85°) and knob on lower side.

Installation on wall or ceiling.

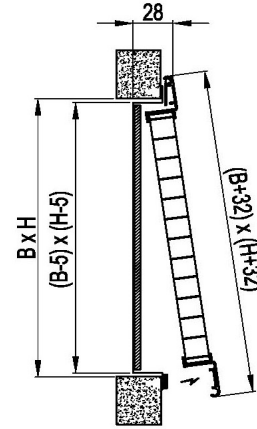

UQ2: fixing with magnets

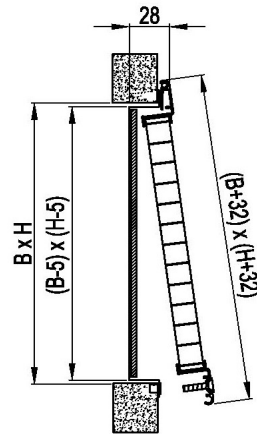

UQ3: fixing with screws

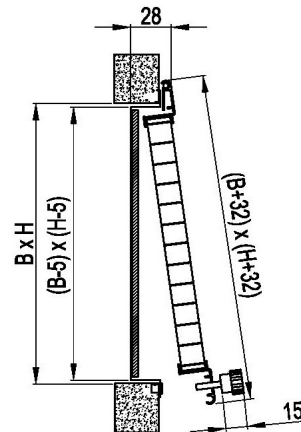

UQ4: fixing with knobs

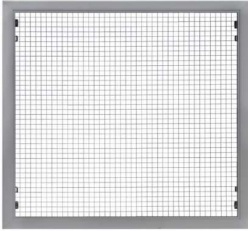

RESIDENTIAL EXTRACT GRILLES

OVERVIEW

UQ SERIES

UQ12: Residential extract grilles with square mesh in anodised extruded aluminium, filterholder frame for 15mm thick rigid filter, opening system: hinge on upper side (maximum angle 85°) and magnet on lower side.
Installation on wall, not ceiling-mount.

UQ13: Residential extract grilles with square mesh in anodised extruded aluminium, filterholder frame for 15mm thick rigid filter, opening system: hinge on upper side (maximum angle 85°) and screws on lower side.
Installation on wall or ceiling.

UQ14: Residential extract grilles with square mesh in anodised extruded aluminium, filterholder frame for 15mm thick rigid filter, opening system: hinge on upper side (maximum angle 85°) and knob on lower side.
Installation on wall or ceiling.

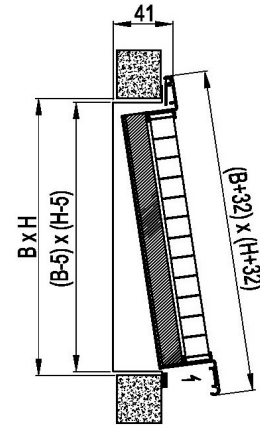

UQ12: fixing with magnets

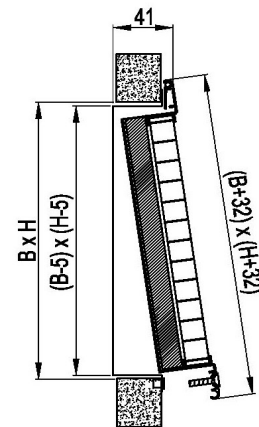

UQ13: fixing with screws

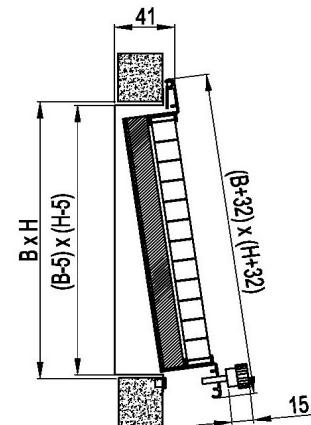

UQ14: fixing with knobs

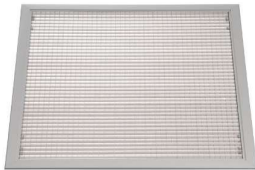

RESIDENTIAL EXTRACT GRILLES

OVERVIEW

UQ SERIES

UQ21: Residential extract grilles with square mesh in anodised extruded aluminium, filterholder frame for washable filter (initial thickness 15 mm), opening system: by clips on both sides. Installation on wall, not ceiling-mount.

UQ22: Residential extract grilles with square mesh in anodised extruded aluminium, filterholder frame for washable filter (initial thickness 15 mm), opening system: by magnets on both sides. Installation on wall, not ceiling-mount.

UQ23: Residential extract grilles with square mesh in anodised extruded aluminium, filterholder frame for washable filter (initial thickness 15 mm), opening system: by screws on both sides. Installation on wall or ceiling.

UQ24: Residential extract grilles with square mesh in anodised extruded aluminium, filterholder frame for washable filter (initial thickness 15 mm), opening system: by knobs on both sides. Installation on wall or ceiling.

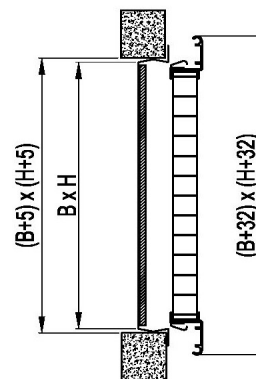

UQ21: fixing with clips

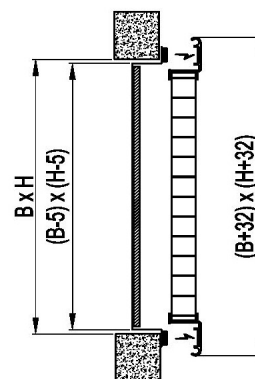

UQ22: fixing with magnets

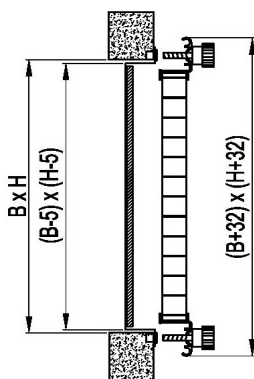

UQ24: fixing with knobs

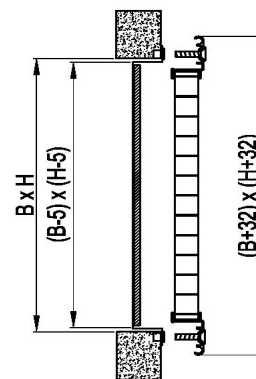

UQ23: fixing with screws

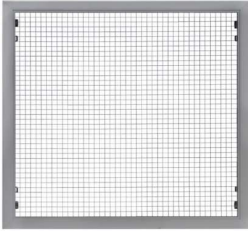

RESIDENTIAL EXTRACT GRILLES

PERFORMANCE

UQ SERIES

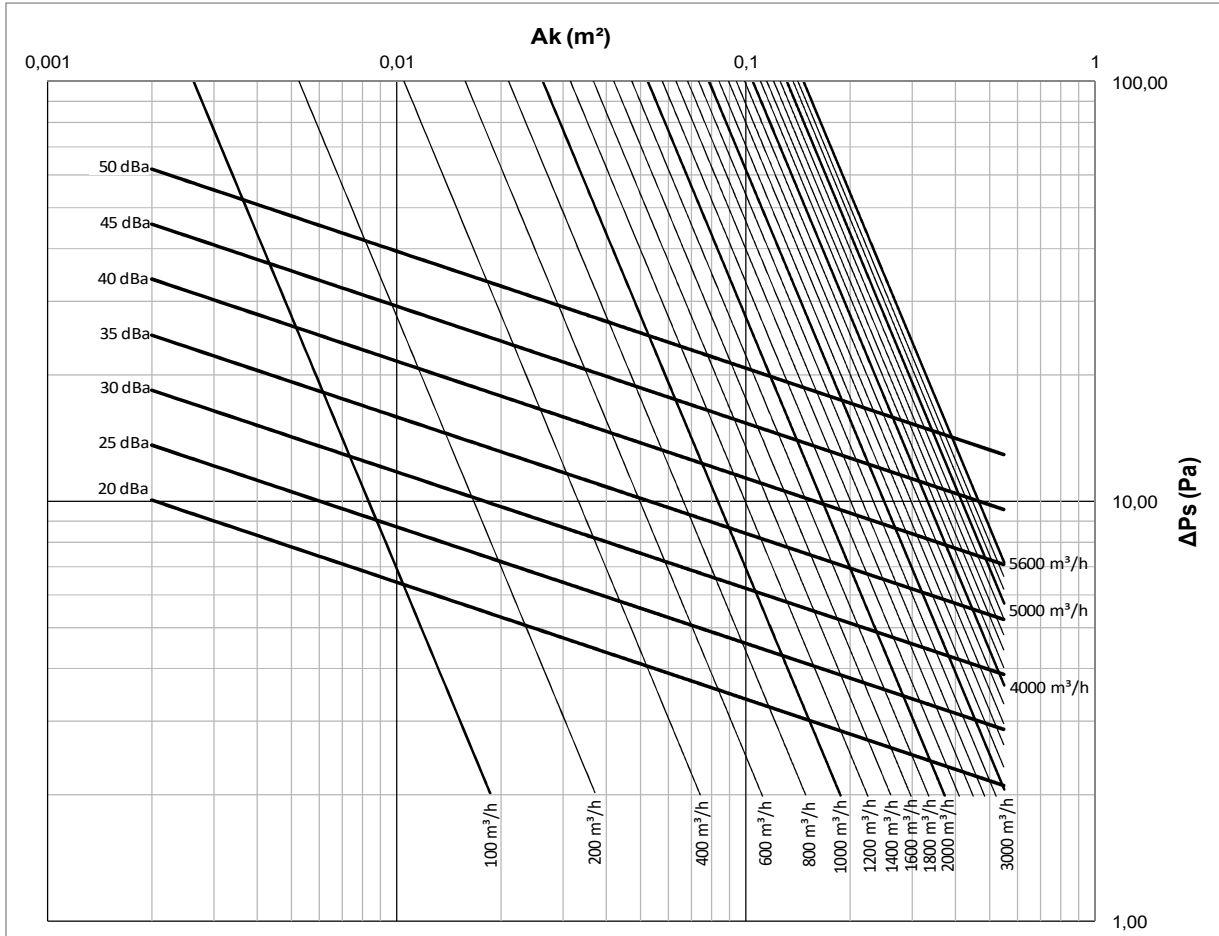

EFFECTIVE AREA A_k [m²]

HEIGHT [mm]	BASE [mm]																			
	100	200	300	400	500	600	700	800	900	1000	1100	1200	1300	1400	1500	1600	1700	1800	1900	2000
75	0,003	0,009	0,015	0,022	0,028	0,034	0,041	0,047	0,053	0,059	0,066	0,072	0,078	0,085	0,091	0,097	0,104	0,110	0,116	0,123
100	0,005	0,013	0,022	0,030	0,038	0,047	0,055	0,064	0,072	0,080	0,089	0,097	0,106	0,114	0,123	0,131	0,139	0,148	0,156	0,165
200	0,013	0,030	0,047	0,064	0,080	0,097	0,114	0,131	0,148	0,165	0,181	0,198	0,215	0,232	0,249	0,265	0,282	0,299	0,316	0,333
300	0,022	0,047	0,072	0,097	0,123	0,148	0,173	0,198	0,223	0,249	0,274	0,299	0,324	0,350	0,375	0,400	0,425	0,450	0,476	0,501
400	0,030	0,064	0,097	0,131	0,165	0,198	0,232	0,265	0,299	0,333	0,366	0,400	0,434	0,467	0,501	0,535	0,568	0,602	0,635	0,669
500	0,038	0,080	0,123	0,165	0,207	0,249	0,291	0,333	0,375	0,417	0,459	0,501	0,543	0,585	0,627	0,669	0,711	0,753	0,795	0,837
600	0,047	0,097	0,148	0,198	0,249	0,299	0,350	0,400	0,450	0,501	0,551	0,602	0,652	0,703	0,753	0,804	0,854	0,905	0,955	1,005
700	0,055	0,114	0,173	0,232	0,291	0,350	0,408	0,467	0,526	0,585	0,644	0,703								
800	0,064	0,131	0,198	0,265	0,333	0,400	0,467	0,535	0,602	0,669	0,736	0,804								
900	0,072	0,148	0,223	0,299	0,375	0,450	0,526	0,602	0,678	0,753	0,829	0,905								
1000	0,080	0,165	0,249	0,333	0,417	0,501	0,585	0,669	0,753	0,837	0,921	1,005								
1100	0,089	0,181	0,274	0,366	0,459	0,551	0,644	0,736	0,829	0,921	1,014	1,106								
1200	0,097	0,198	0,299	0,400	0,501	0,602	0,703	0,804	0,905	1,005	1,106	1,207								
1300	0,106	0,215	0,324	0,434	0,543	0,652														
1400	0,114	0,232	0,350	0,467	0,585	0,703														
1500	0,123	0,249	0,375	0,501	0,627	0,753														

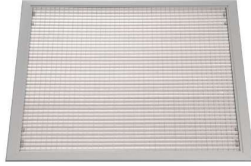

RESIDENTIAL EXTRACT GRILLES

UQ SERIES

WEIGHTS

WEIGHT [kg] UQ NOT FILTERHOLDER

HEIGHT [mm]	BASE [mm]																			
	100	200	300	400	500	600	700	800	900	1000	1100	1200	1300	1400	1500	1600	1700	1800	1900	2000
75	0,15	0,21	0,27	0,33	0,40	0,46	0,52	0,59	0,65	0,72	0,77	0,84	0,91	0,96	1,03	1,09	1,16	1,21	1,30	1,36
100	0,20	0,29	0,37	0,46	0,54	0,63	0,73	0,82	0,91	0,99	1,08	1,17	1,26	1,34	1,43	1,52	1,61	1,69	1,80	1,89
200	0,29	0,43	0,58	0,73	0,88	1,02	1,19	1,34	1,48	1,63	1,78	1,93	2,11	2,26	2,41	2,56	2,70	2,85	3,03	3,17
300	0,38	0,60	0,81	1,02	1,22	1,43	1,68	1,88	2,10	2,31	2,52	2,72	2,98	3,19	3,41	3,61	3,82	4,03	4,28	4,49
400	0,47	0,75	1,02	1,28	1,56	1,83	2,14	2,42	2,69	2,96	3,23	3,50	3,84	4,11	4,37	4,65	4,92	5,18	5,52	5,79
500	0,58	0,91	1,24	1,57	1,91	2,23	2,64	2,97	3,31	3,63	3,97	4,30	4,70	5,03	5,36	5,70	6,02	6,36	6,78	7,11
600	0,69	1,07	1,47	1,87	2,25	2,65	3,13	3,52	3,91	4,31	4,70	5,10	5,57	5,96	6,36	6,75	7,14	7,54	8,03	8,41
700	0,77	1,22	1,68	2,13	2,59	3,04	3,60	4,05	4,50	4,96	5,42	5,87								
800	0,87	1,39	1,90	2,42	2,94	3,46	4,08	4,60	5,12	5,64	6,15	6,67								
900	0,96	1,53	2,11	2,69	3,27	3,85	4,55	5,13	5,71	6,28	6,87	7,45								
1000	1,06	1,70	2,34	2,99	3,62	4,26	5,04	5,69	6,32	6,96	7,60	8,23								
1100	1,17	1,87	2,57	3,27	3,97	4,68	5,54	6,23	6,93	7,64	8,33	9,03								
1200	1,26	2,02	2,78	3,54	4,31	5,07	6,00	6,76	7,53	8,28	9,05	9,81								
1300	1,36	2,18	3,01	3,83	4,66	5,48														
1400	1,46	2,35	3,24	4,12	5,00	5,89														
1500	1,55	2,50	3,45	4,39	5,34	6,29														

WEIGHT [kg] UQ FILTERHOLDER WITH WASHABLE FILTER

HEIGHT [mm]	BASE [mm]														
	200	300	400	500	600	700	800	900	1000	1100	1200	1300	1400	1500	1600
75	0,43	0,56	0,69	0,84	0,97	1,10	1,24	1,38	1,53	1,65	1,79	1,94	2,06	2,20	2,35
100	0,47	0,61	0,76	0,91	1,05	1,18	1,34	1,48	1,63	1,77	1,92	2,08	2,22	2,37	2,52
200	0,65	0,82	1,01	1,19	1,35	1,54	1,71	1,89	2,07	2,23	2,42	2,61	2,80	2,97	3,16
300	0,82	1,04	1,25	1,44	1,67	1,87	2,07	2,29	2,49	2,72	2,91	3,18	3,39	3,60	3,80
400	1,01	1,25	1,48	1,73	1,96	2,21	2,45	2,69	2,94	3,17	3,42	3,74	3,99	4,22	4,45
500	1,19	1,44	1,73	2,00	2,27	2,55	2,82	3,10	3,37	3,65	3,93	4,30	4,55	4,83	5,11
600	1,35	1,67	1,96	2,27	2,58	2,88	3,20	3,50	3,82	4,11	4,43	4,84	5,14	5,46	5,76
700	1,54	1,87	2,21	2,55	2,88	3,23	3,56	3,91	4,24	4,60	4,92	5,39	5,74	6,07	6,41
800	1,71	2,07	2,45	2,82	3,20	3,56	3,93	4,31	4,69	5,05	5,43	5,96	6,31	6,69	7,06
900	1,89	2,29	2,69	3,10	3,50	3,91	4,31	4,73	5,12	5,52	5,93	6,50	6,91	7,31	7,72
1000	2,07	2,49	2,94	3,37	3,82	4,24	4,69	5,12	5,56	5,99	6,42	7,06	7,50	7,92	8,36
1100	2,23	2,72	3,17	3,65	4,11	4,60	5,05	5,52	5,99						
1200	2,42	2,91	3,42	3,93	4,43	4,92	5,43	5,93	6,42						
1300	2,61	3,18	3,74	4,30	4,84	5,39	5,96	6,50	7,06						
1400	2,80	3,39	3,99	4,55	5,14	5,74	6,31	6,91	7,50						
1500	2,97	3,60	4,22	4,83	5,46	6,07	6,69	7,31	7,92						
1600	3,16	3,80	4,45	5,11	5,76	6,41	7,06	7,72	8,36						

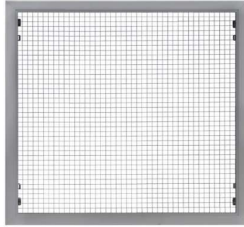

RESIDENTIAL EXTRACT GRILLES

WEIGHTS

UQ SERIES

WEIGHT [kg] UQ FILTERHOLDER WITH RIGID FILTER

HEIGHT [mm]	BASE [mm]															
	200	300	400	500	600	700	800	900	1000	1100	1200	1300	1400	1500	1600	
100	0,29	0,37	0,46	0,54	0,62	0,61	0,68	0,74	0,82	0,89	0,97	1,05	1,12	1,20	1,26	
200	0,40	0,51	0,61	0,73	0,84	0,75	0,84	0,92	1,00	1,09	1,17	1,30	1,38	1,46	1,55	
300	0,50	0,64	0,78	0,91	1,06	0,90	1,00	1,10	1,20	1,30	1,40	1,55	1,65	1,74	1,84	
400	0,60	0,77	0,94	1,11	1,27	1,05	1,16	1,27	1,39	1,50	1,62	1,80	1,91	2,03	2,14	
500	0,71	0,90	1,10	1,30	1,49	1,19	1,33	1,45	1,59	1,71	1,83	2,05	2,18	2,30	2,43	
600	0,81	1,04	1,26	1,48	1,71	1,34	1,48	1,63	1,77	1,91	2,05	2,30	2,45	2,58	2,72	
700	0,72	0,87	1,03	1,18	1,33	1,49	1,65	1,81	1,96	2,11	2,28	2,55	2,70	2,86	3,02	
800	0,80	0,97	1,13	1,31	1,47	1,64	1,82	1,98	2,15	2,32	2,49	2,81	2,97	3,14	3,32	
900	0,86	1,05	1,23	1,41	1,60	1,78	1,97									
1000	0,94	1,14	1,34	1,54	1,73	1,93	2,12									
1100	1,02	1,23	1,44	1,66	1,86	2,08	2,29									
1200	1,09	1,33	1,55	1,77	2,00	2,23	2,46									
1300	1,21	1,47	1,73	1,98	2,25	2,50	2,76									
1400	1,29	1,56	1,83	2,11	2,38	2,66	2,93									
1500	1,36	1,65	1,94	2,23	2,52	2,80	3,10									
1600	1,44	1,74	2,04	2,34	2,64	2,94	3,24									

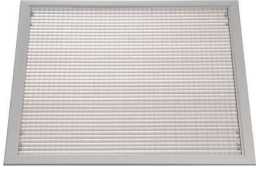

RESIDENTIAL EXTRACT GRILLES

UQ SERIES

HOW TO ORDER

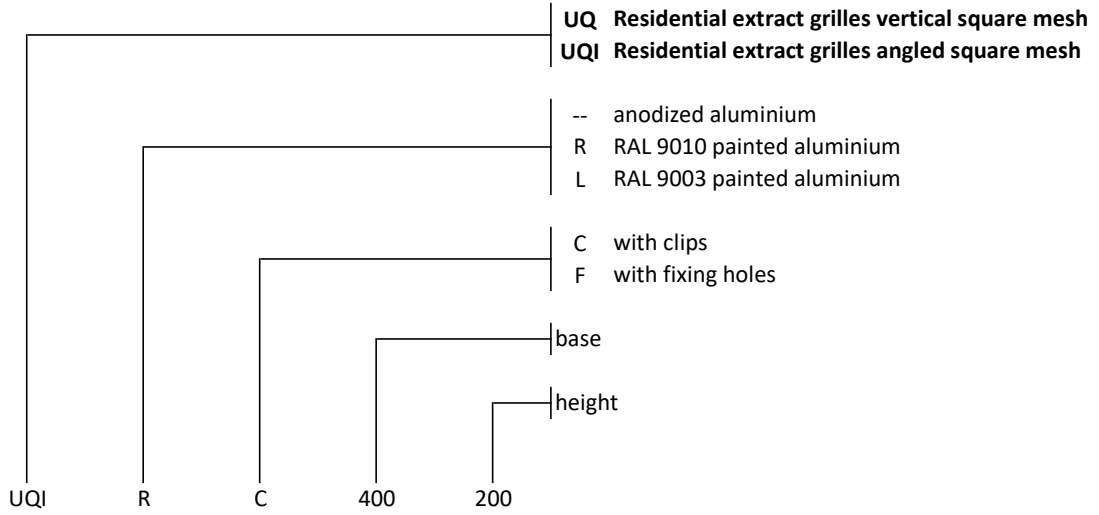

FEASIBLE SIZES - STANDARD STEP 50mm

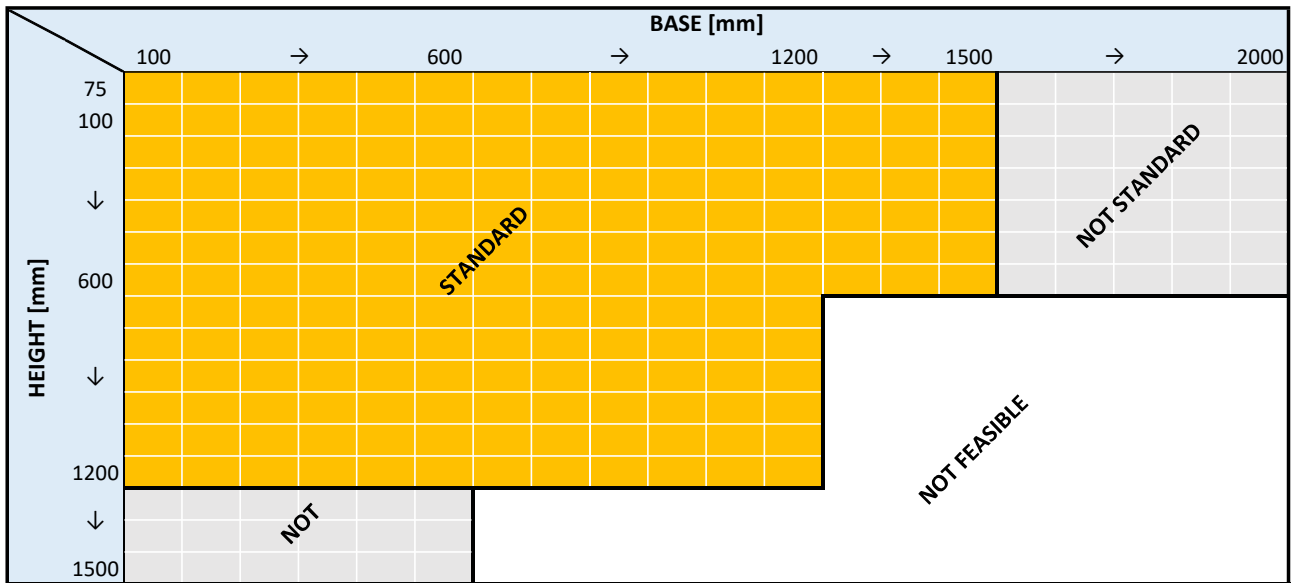

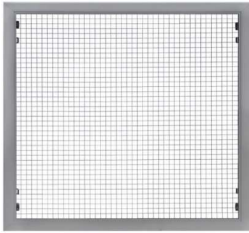

RESIDENTIAL EXTRACT GRILLES

UQ SERIES

HOW TO ORDER FILTERHOLDER VERSIONS

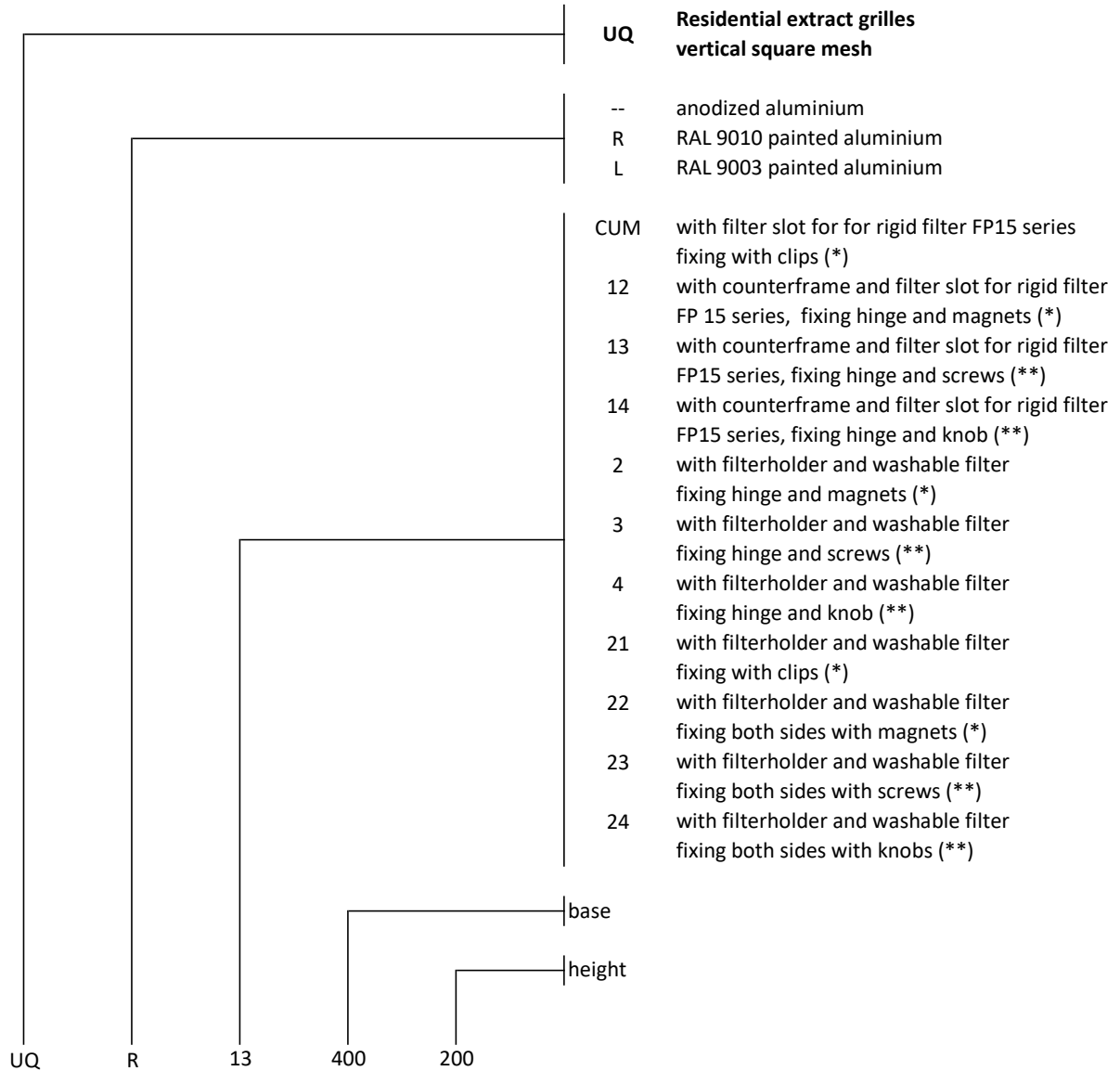

(*) Installation on wall, not ceiling-mount

(**) Installation on wall or ceiling
 With hinge and rigid filter H min 150mm
 With hinge and washable filter H min 100mm

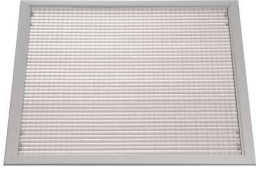

RESIDENTIAL EXTRACT GRILLES

UQ
SERIES

FEASIBLE SIZES
FILTERHOLDER VERSIONS
WASHABLE FILTER

FEASIBLE SIZES - WASHABLE FILTER - WITH HINGES - 50mm PITCH

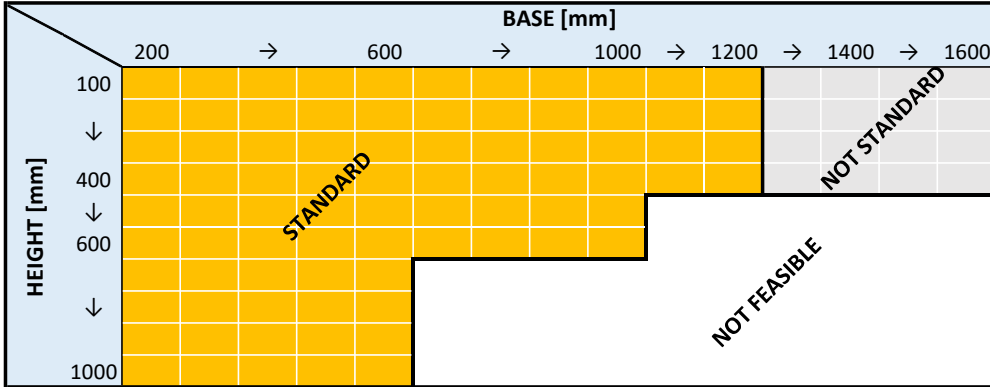

FEASIBLE SIZES - WASHABLE FILTER - FIXING WITH MAGNETS - 50mm PITCH

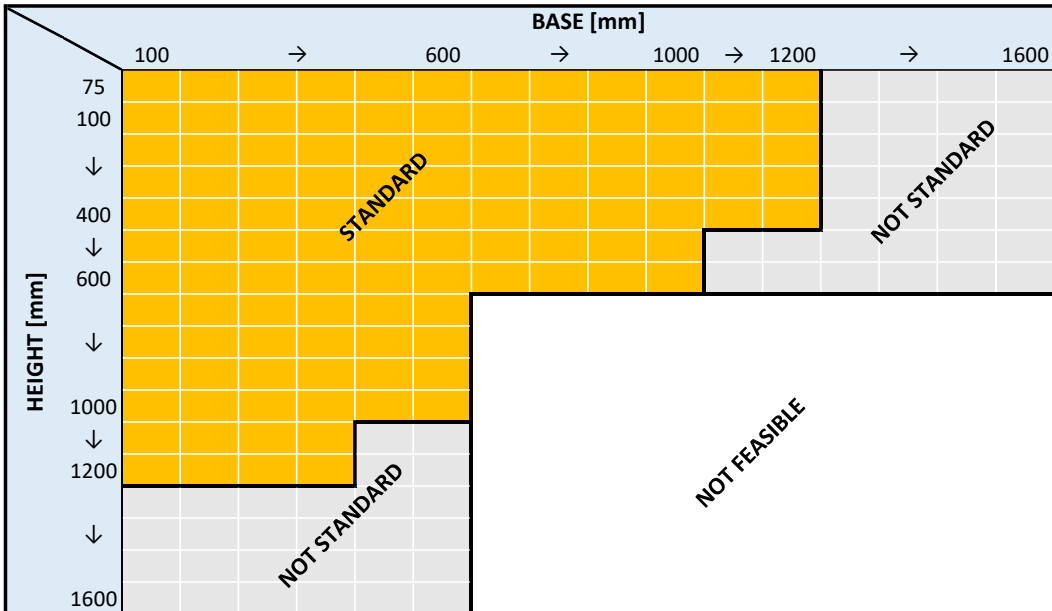

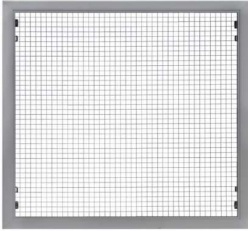

RESIDENTIAL EXTRACT GRILLES

UQ SERIES

FEASIBLE SIZES
FILTERHOLDER VERSIONS
WASHABLE FILTER

FEASIBLE SIZES - WASHABLE FILTER - FIXING WITH SCREWS OR KNOBS - 50mm PITCH

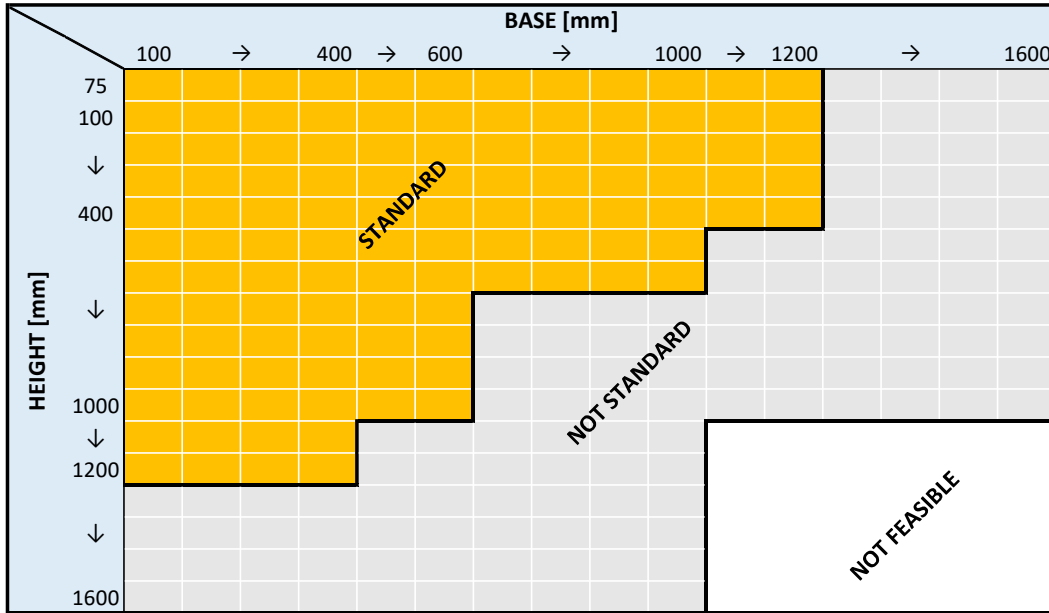

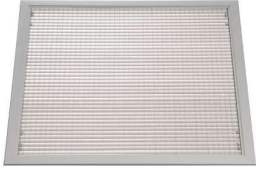

**RESIDENTIAL
EXTRACT GRILLES**

**UQ
SERIES**

**FEASIBLE SIZES
FILTERHOLDER VERSIONS
RIGID FILTER**

FEASIBLE SIZES - RIGID FILTER - WITH HINGE - 50mm PITCH

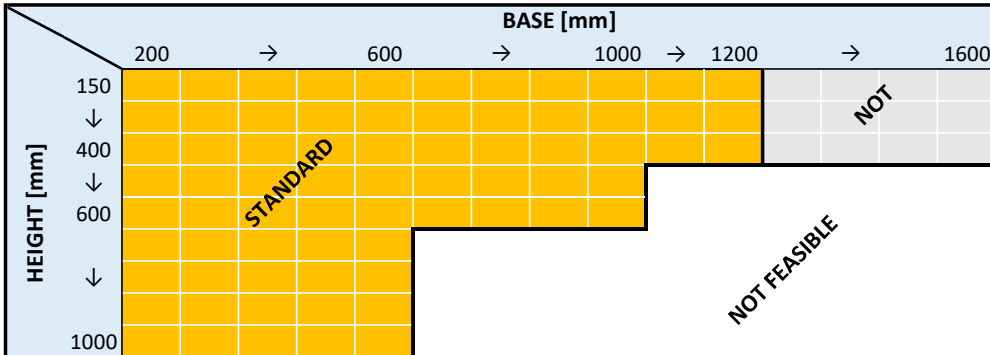

**FEASIBLE SIZES - RIGID FILTER - FIXING WITH CLIPS OR MAGNETS OR SCREWS OR KNOBS
50mm PITCH**

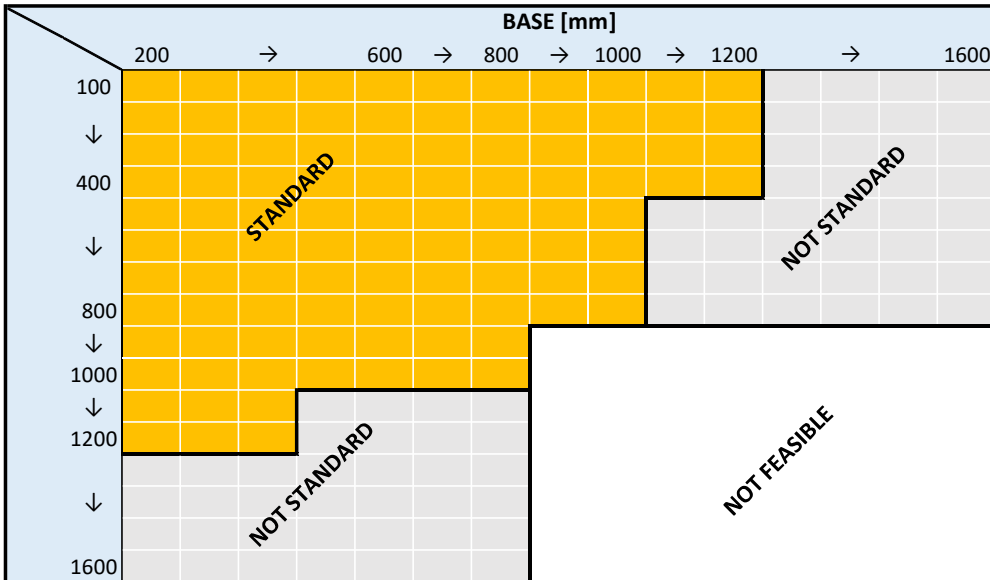

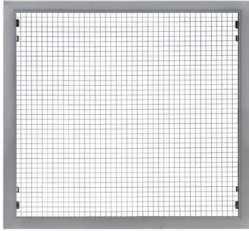

**RESIDENTIAL
EXTRACT GRILLES**

STANDARD FIXING METODS

**UQ
SERIES**

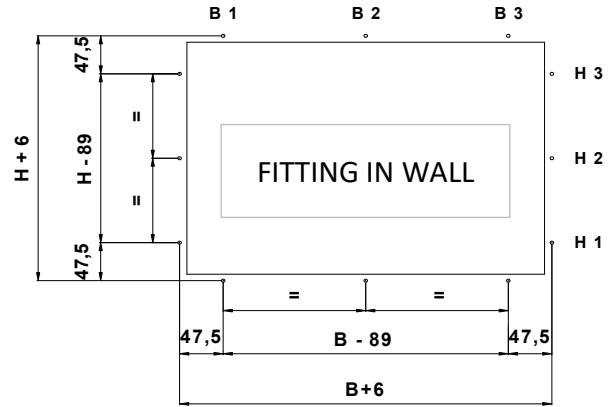
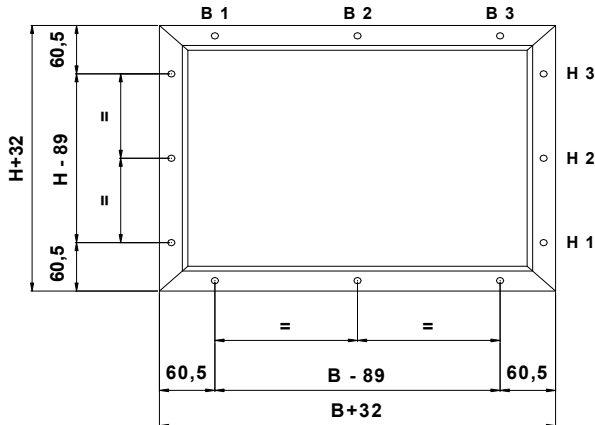

REFERENCE TO NOMINAL SIZES OF GRILLE

B=BASE

H= HEIGHT

NECESSARY HOLES							
B	B1	B2	B3	H	H1	H2	H3
100				100		X	
200				200		X	
300				300		X	
400				400	X		X
				500	X		X
				600	X		X
				700	X		X
				800	X	X	X
				900	X	X	X
				1000	X	X	X
				1100	X	X	X
				1200	X	X	X
				1300	X	X	X
				1400	X	X	X

NECESSARY HOLES							
B	B1	B2	B3	H	H1	H2	H3
500	X		X	100			
600	X		X	200			
700	X		X	300			
800	X	X	X	400			
900	X	X	X	500			
1000	X	X	X	600		X	
1100	X	X	X	700		X	
1200	X	X	X	800		X	
1300	X	X	X	900		X	
1400	X	X	X	1000	X	X	X
1500	X	X	X	1100	X	X	X
				1200	X	X	X
				1300	X	X	X
				1400	X	X	X
				1500	X	X	X

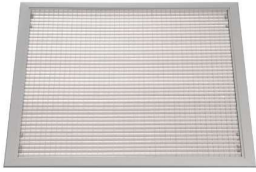

RESIDENTIAL GRILLES

HIDDEN SCREWS FIXING

U-FIX SERIES

Fixing with hidden screw

The U-FIX kit allows a quick fixing of the grille to the counterframe simply rotating a hidden screw behind the front fins.

The kit is suitable for grilles with two rows or a single row of fins.

This solution allows you to quickly disassemble and reassemble the grid for any cleaning or maintenance.

The kit consists of two or four elements, depending on the size of the grille.

The kit comes already assembled on the grille.

For the sizes up to 1000x300 and 600x600 it is possible to provide an SC damper mounted during manufacturing on the grille frame.

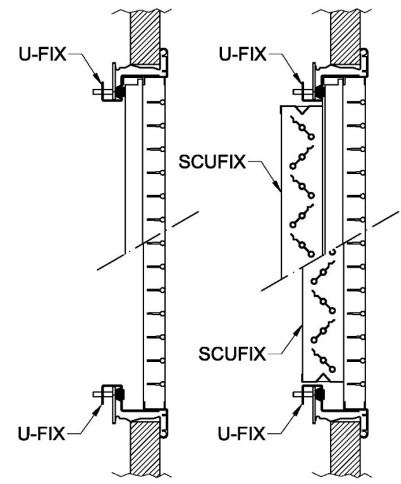

Grille with
hidden screws fixing

HEIGHT [mm]	BASE [mm]			
	200	→ 600	→ 1000	→ 1200
75	U-FIX2 compatible with the damper SCUFIX			
100				
↓ 300				
↓ 600	U-FIX4 not compatible with the damper SCUFIX			
↓ 1000				

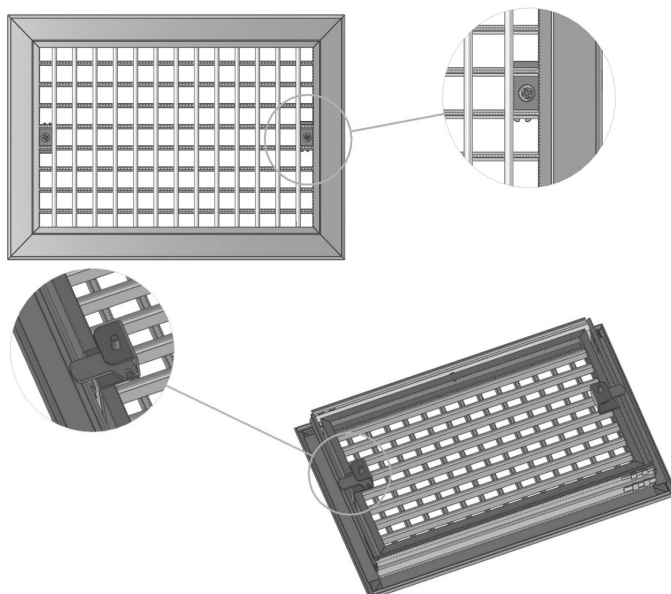

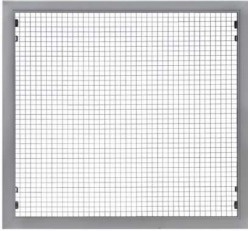

RESIDENTIAL GRILLES

HIDDEN SCREWS FIXING
HOW TO ORDER

U-FIX
SERIES

HOW TO ORDER

The code of the grille must be with "clips configuration" (not with "holes configuration").
Standard clips will not be provided in presence of U-FIX kit mounted.

The counterframe must be ordered according to standard counterframe dimension.
In case of regulation damper request, please use the specific code SCUFIX

ORDER EXAMPLES

Grille UM 400x200mm with U-FIX and counterframe

1)	UM1HC400200	q.ty	1
2)	U-FIX2	q.ty	1
3)	UTCC0400200	q.ty	1

Grille UM 700x400mm with U-FIX and counterframe

1)	UM1HC700400	q.ty	1
2)	U-FIX4	q.ty	1
3)	UTCC0700400	q.ty	1

Grille UM 400x200mm with U-FIX , counterframe and regulation damper

1)	UM1HC400200	q.ty	1
2)	U-FIX2	q.ty	1
3)	UTCC0400200	q.ty	1
4)	SCUFIX400200	q.ty	1

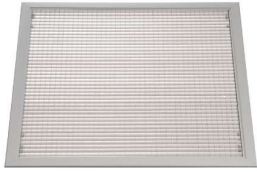

RESIDENTIAL GRILLES

UQ SERIES

ACCESSORIES



PP30 Plenum with rear connection
insulated and non insulated version



PP40 Plenum with lateral connection
insulated and non insulated version



SC Control damper



UTC Counterframe



**PLENUM FOR
VENTILATION GRILLES**

**PP 30
SERIES**

TECHNICAL CHARACTERISTICS

L	H	A	N°	S
200	100	140	1	80
300	100	140	1	80
400	100	140	1	80
500	100	140	2	80
600	100	140	2	80
700	100	140	2	80
800	100	140	2	80
200	150	180	1	127
300	150	180	1	127
400	150	180	1	127
500	150	180	2	127
600	150	180	2	127
700	150	180	2	127
800	150	180	2	127
900	150	180	2	127
1000	150	180	2	127
200	200	220	1	150
300	200	220	1	150
400	200	220	1	180
500	200	220	1	180
600	200	220	2	150
700	200	220	2	150
800	200	220	2	150
900	200	220	2	180
1000	200	220	2	180
200	250	220	1	200
300	250	220	1	200
400	250	220	1	200
500	250	220	1	200
600	250	220	2	150
700	250	220	2	150
800	250	220	2	150
900	250	220	2	180
1000	300	220	2	180
300	300	260	1	250
400	300	260	1	250
500	300	260	1	250
600	300	260	2	160
700	300	260	2	160
800	300	260	2	160
900	300	260	2	200
1000	300	260	2	200
400	400	260	1	350
500	400	260	1	350
600	400	260	2	160
700	400	260	2	160
800	400	260	2	160
900	400	260	2	200
1000	400	260	2	200

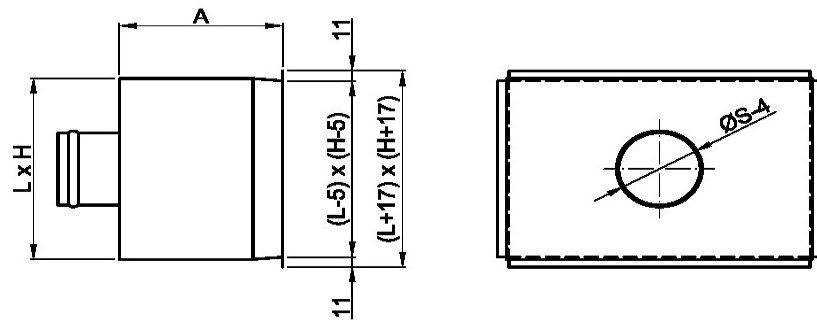
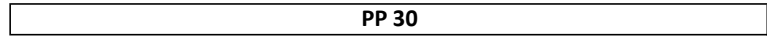

STANDARD GRILLE

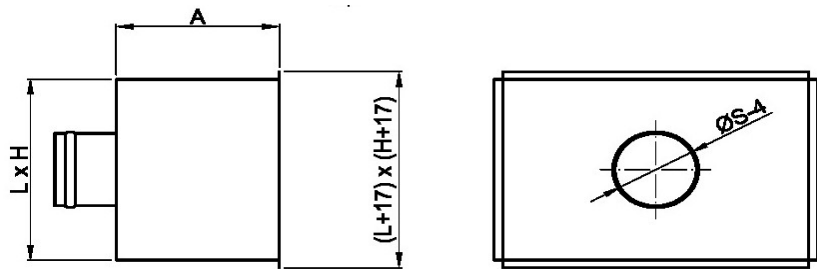

GRILLE WITH FILTERHOLDER FRAME

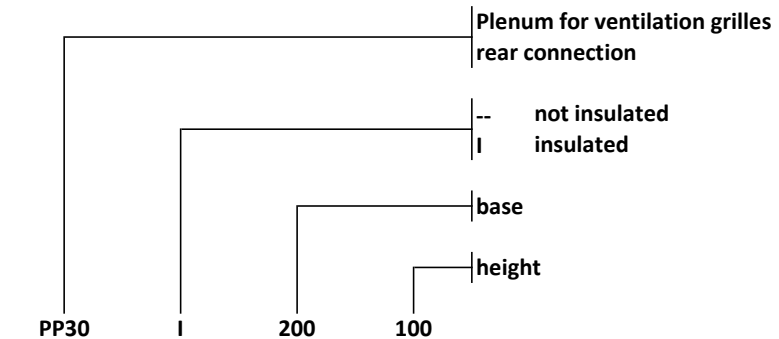

For S = 125 - 160 - 200 - 250 connection in ABS - steel on request
For other diameters connection in steel



**PLENUM FOR
VENTILATION GRILLES**

**PP 40
SERIES**

TECHNICAL CHARACTERISTICS

L	H	A	B	C	N°	S
200	100	200	70	80	1	100
300	100	250	95	80	1	150
400	100	250	95	80	1	150
500	100	300	120	80	1	200
600	100	300	120	80	1	200
700	100	350	145	80	1	250
800	100	350	145	80	1	250
200	150	250	95	80	1	150
300	150	300	120	80	1	200
400	150	300	120	80	1	200
500	150	350	145	80	1	250
600	150	350	145	80	1	250
700	150	350	145	80	1	250
800	150	415	178	80	1	315
900	150	415	178	80	1	315
1000	150	415	178	80	1	315
200	200	250	95	80	1	150
300	200	250	95	80	1	150
400	200	350	145	80	1	250
500	200	350	145	80	1	250
600	200	415	178	80	1	315
700	200	415	178	80	1	315
800	200	415	178	80	1	315
900	200	450	195	80	1	350
1000	200	450	195	80	1	350
200	250	300	120	80	1	200
300	250	300	120	80	1	200
400	250	350	145	80	1	250
500	250	350	145	80	1	250
600	250	415	178	80	1	315
700	250	415	178	80	1	315
800	250	415	178	80	1	315
900	250	450	195	80	1	350
1000	250	450	195	80	1	350
300	300	350	145	80	1	250
400	300	415	178	80	1	315
500	300	450	195	80	1	350
600	300	450	195	80	1	350
700	300	450	195	80	1	350
800	300	450	195	80	1	350
900	300	500	220	80	1	400
1000	300	500	220	80	1	400
400	400	450	195	80	1	350
500	400	450	195	80	1	350
600	400	450	195	80	1	350
700	400	450	195	80	1	350
800	400	450	195	80	1	350
900	400	500	220	80	1	400
1000	400	500	220	80	1	400

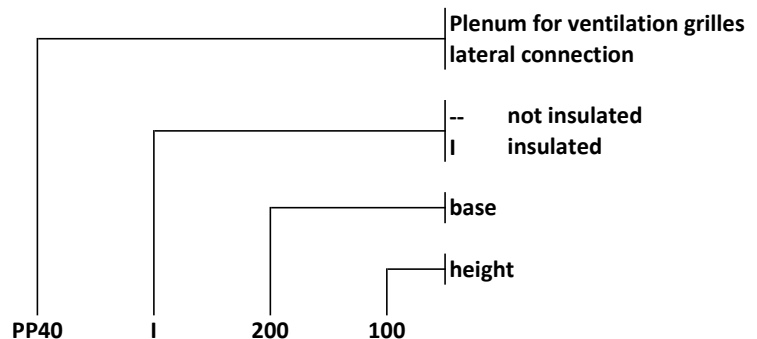
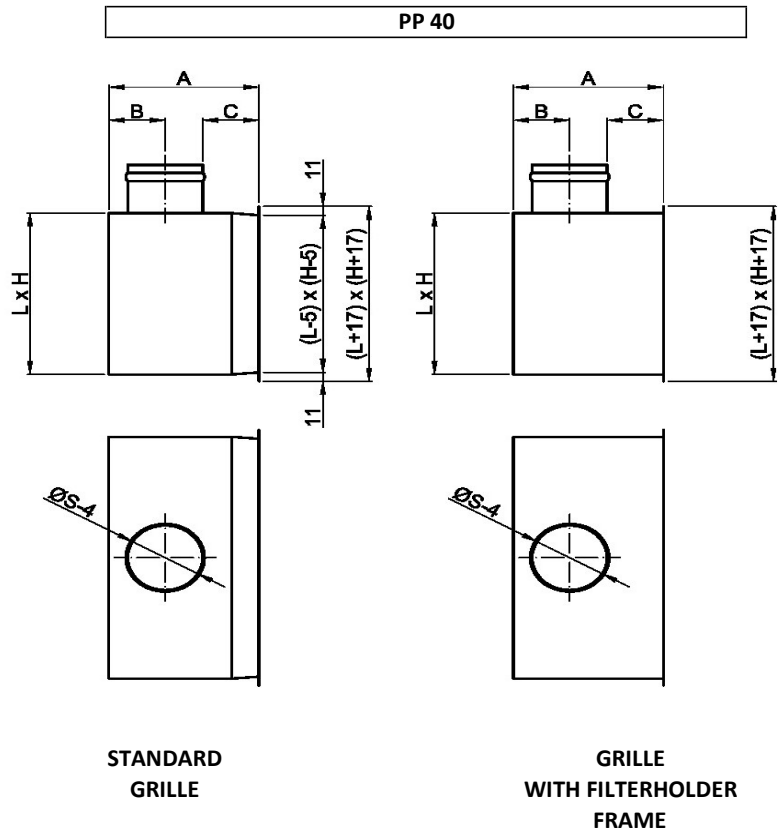

For S = 125 - 160 - 200 - 250 connection in ABS - steel on request
For other diameters connection in steel



CONTROL DAMPERS

SC SERIES

OVERVIEW TECHNICAL CHARACTERISTICS

OVERVIEW AND CHARACTERISTICS :

The contrast control dampers of SC series can be fitted to UF KG UM UR GI KN e CR-KN series . They are held in place by special patented clips, designed both for fitting the damper to the grill and for fitting it on a false frame.

The SC series dampers are made entirely of galvanised steel and have a mechanism for moving and closing all the blades simultaneously.

This mechanism is a simple longitudinal plate that links all the blades, and can be removed by unscrewing a nut using a screwdriver. The careful design, precise assembly, and the quality of the materials used, make this an economical, practical, and efficient component.

Contrast control damper- dimensions that can be created in a single solution

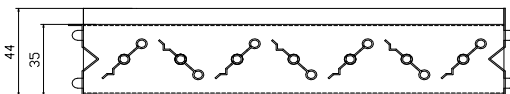
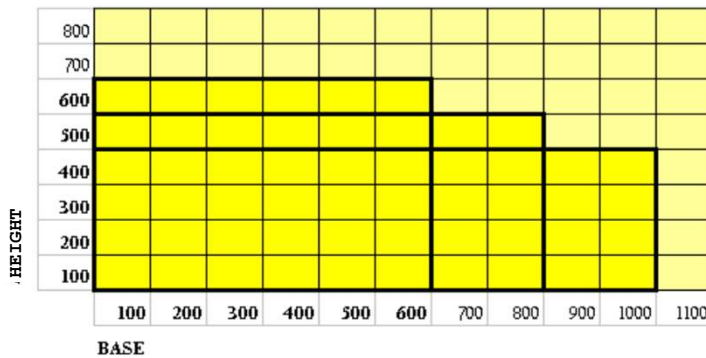

Contrast control damper - overall dimensions

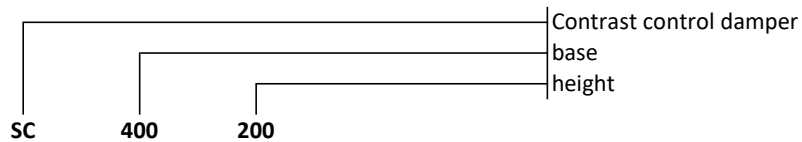
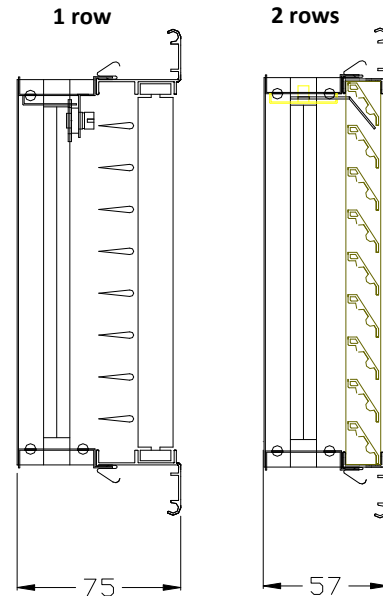



COUNTERFRAMES FOR SUPPLY AND RETURN GRILLES

UTC
SERIES

OVERVIEW

OVERVIEW

The UTC series counterframes used for supply and return grilles are a strong frame on which the fixing clips can rest. They are required if the grilles need to be frequently removed for cleaning, inspection, filter changing and other similar jobs.

The UTC counterframes can be installed both next to steel ducts and on masonry walls.

Bendable parts are placed inside the fixing agent of the wall and a frame that will be completely hidden from the frame of the grille itself, for fixing by means of screws or rivets to the duct wall.

The use of the counterframe on the side of the steel duct allows the use of grilles with fixing clips rather than with screws, therefore allowing to undertake jobs that require removing and reinstalling the grille with the up most simplicity without the need of tools.

The use of the counterframe on masonry walls allows for an almost unlimited number of removals and replacements of the grille without ever damaging or wearing-out the border of the hole made in the wall. The position of the grille can therefore be maintained, precise and secure.

TECHNICAL CHARACTERISTICS

The UTC Series counterframes are made of four separate parts, of galvanized carbon steel sheet, fixable to each other without the need of tools. The parts are completely interchangeable as the particular system of connection eliminated the need to distinguish between horizontal and vertical parts and with between left and right parts.

As shown in the illustration, the necessary space for the counterframe needs to be 5mm more than the nominal size of the grille.

AVAILABLE SIZES

The available sizes for each part range from 100mm up to a maximum of 1400mm, in multiples of 50mm. Special sizes are also available on request. By composing the various sizes, all the necessary sizes are achievable.

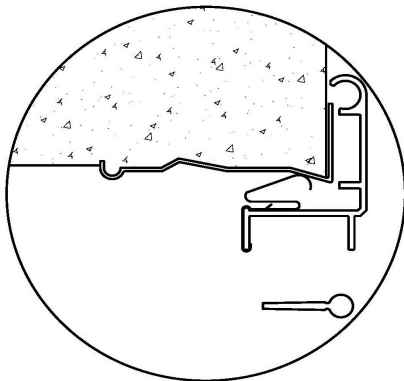
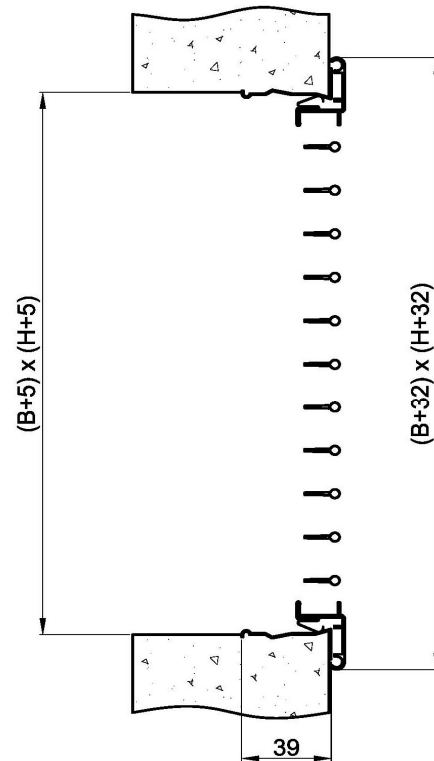

Mounting with single deflection grille

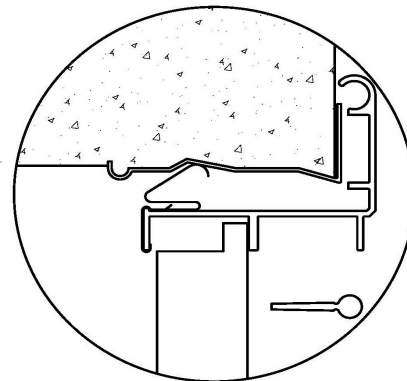

Mounting with double deflection grille



COUNTERFRAMES FOR SUPPLY AND RETURN GRILLES

UTC
SERIES

OVERVIEW

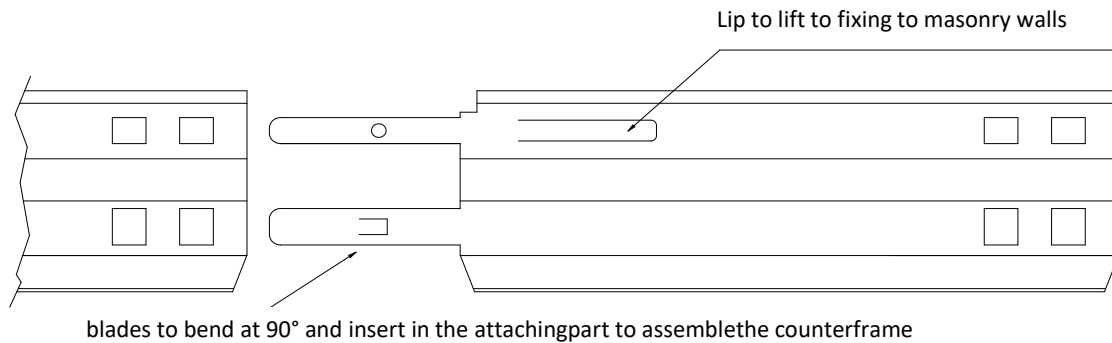

Detail of the fixing method between parts

This system allows to quickly assemble the counterframe, even during the construction fase.

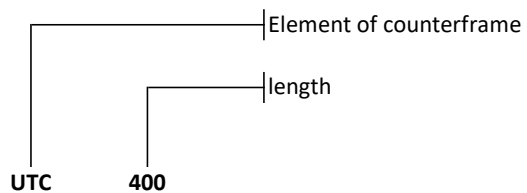

Example:

To order a counterframe for a 400x200mm grille,
request:

UTC-400 - 2 pieces

UTC-200 - 2 pieces

To order a counterframe for a 300x300 grille, request:

UTC-300 - 4 pieces